

Article number: 090612830

Description: KLEE Feather keys B 12x8x30 DIN 6885

Measures

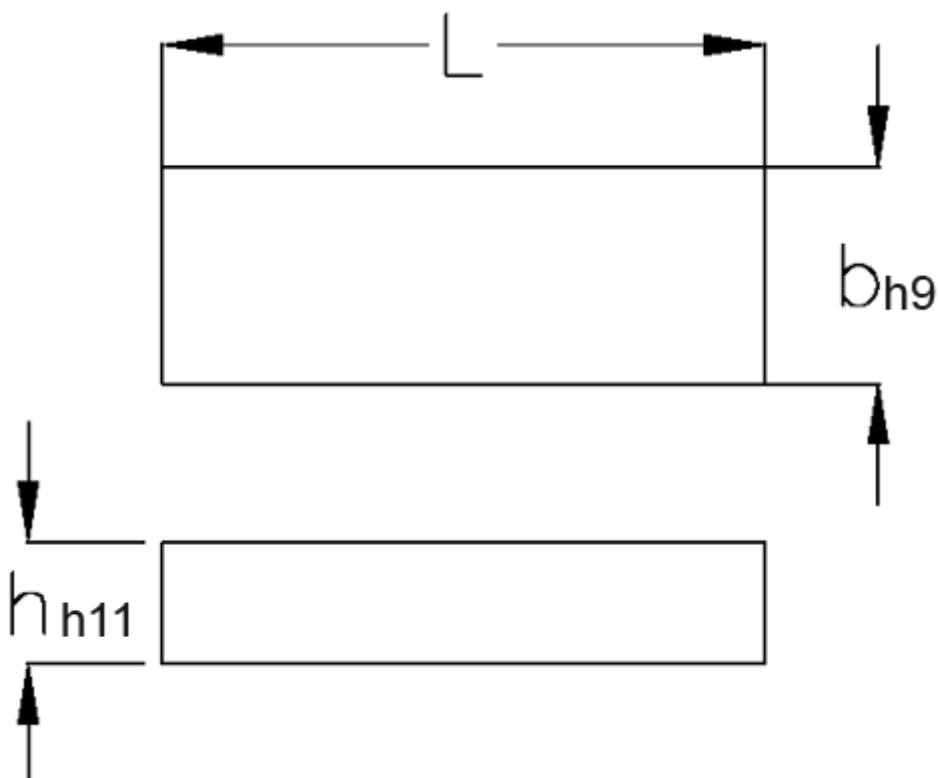

b = 12

h = 8

L = 30

Tolerance b = 0.043

Tolerance h = 0.090

Tolerance L = -0,3